

# BeoVision 11

BeoVision 11-40

BeoVision 11-46

BeoVision 11-55

## Dear Customer

This guide contains additional information about your product and describes some features and functions from the Getting Started in more detail. Among other things you can find information about settings, how to operate your product with a Bang & Olufsen remote control, and how to set up a wired or wireless connection.

This guide will be updated on a regular basis to make it reflect, for example, new features and functions introduced with software updates. When your television receives new features and functions, you can also read about them in the NICE TO KNOW menu under SETUP.

You can find additional information about your product in the Frequently Asked Questions (FAQ) section on [www.bang-olufsen.com/customerservice](http://www.bang-olufsen.com/customerservice).

# Contents – Click a headline to move to that section

## **Understanding the guide, 4**

See how to use the illustrated menu operations and the remote controls.

## **Set positions for the television to turn to, 6**

How to preset positions for a motorised stand or wall bracket to turn to.

## **Connections, 7**

Examples of where to connect additional equipment and how to connect a PC or camera. How to reset to default settings.

## **Set up additional equipment, 13**

How to register connected equipment in the SOURCE LIST SETUP menu.

## **Use channels, groups and lists, 15**

How to make, edit and use groups and lists, edit and add channels and how to watch Pay Per View channels if available.

## **Re-tune channels, 18**

How to update channels or reinstall all channels.

## **Loudspeaker setup – surround sound, 20**

How to make your television part of a surround sound system.

## **Adjust sound and picture settings, 23**

How to make sound and picture settings and use picture modes.

## **Set up 3D television, 25**

How to make settings for watching 3D television.

## **Daily use of sound modes and speaker groups, 26**

How to switch between different sound modes and speaker groups.

## **See two sources at the same time, 28**

How to see two sources at the same time.

## **Programme information, 29**

How to bring up programme information and change subtitles and audio options.  
How to bring up HbbTV.

## **Record a programme, 32**

How to set a Timer, bring up a list of Timers and copy from the timeshift buffer to the optional hard disk recorder.

## **Edit recordings, 36**

How to protect, name, sort, trim, split or delete recordings. You can also change category or activate a Parental Lock.

## **WebMedia, 37**

How to navigate in web pages and add apps using WebMedia.

## **HomeMedia, 39**

How to browse your photos and play back your music files on your television.

## **Sleep Timers, 42**

How to make your television switch off automatically.

## **Power settings, 43**

How to make settings for power consumption and auto standby. How to reduce the start-up time.

## **Access control, 44**

How to make an access code to prevent others from editing channel settings and watching channels or recordings.

## **HDMI Matrix, 45**

How to enter settings in the HDMI MATRIX menu.

## **The pin code system, 46**

How to use the pin code system.

## **Software and service update, 47**

How to update software and find information about modules.

## **Peripheral Unit Controller tables, 48**

How to download and remove PUC tables.

## **Digital Text, 49**

How to enable or disable Digital Text for MHEG operation.

## **Teletext, 50**

How to store favourite teletext pages as MEMO pages.

## **Operate other equipment with Beo4 or Beo6, 52**

How to operate connected equipment, such as set-top boxes, DVD players or the like.

## **Network settings, 54**

How to set up a network and bring up network information.

## **Distribute sound with Network Link, 57**

How to make link connections and operate a link system.

## **Connect and operate an audio system, 59**

How to connect an audio system to your television and operate an integrated audio/video system.

## **Operate two televisions in one room, 61**

Option programming and operation of two televisions in the same room.

## **Two televisions – with Network Link connection, 62**

How to connect another television to television and operate an integrated video system.

# Understanding the guide

## Menu operation

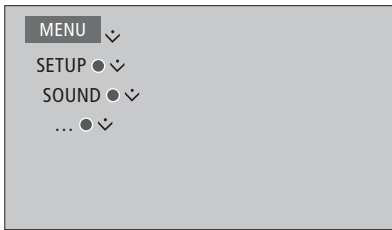

This menu hierarchy illustrates the path into a menu where you can make different settings. Press **MENU** on your remote control and use the navigation button down and the **centre** button to select and open the menu.

When available, you can also press the **blue** button on your remote control to bring up help texts.

*Example of menu operation.*

---

## Remote control operation

*To activate picture modes with Beo4 directly ...*

Press to bring up **PICTURE** in the Beo4 display

Press to select a picture mode

Step between modes

Press and hold to remove **PICTURE** from the display

Where relevant, the remote control operation will be shown.

- A dark grey button indicates a hard button you must press.
- A light grey button indicates a Beo4/Beo6 soft button. Press **LIST** on Beo4 to bring them up. (Beo6: Press  $\triangle$ ). The button appears in the Beo4/Beo6 display.

- The navigation button is symbolised by  $\langle \diamond \rangle$  and is used to indicate in which direction you must move the navigation button.
- The **centre** button is symbolised by  $\bullet$  and is used when you must press the **centre** button.

*Example of Beo4 remote control operation.*

*Continues ...*

## Beo4 with navigation button

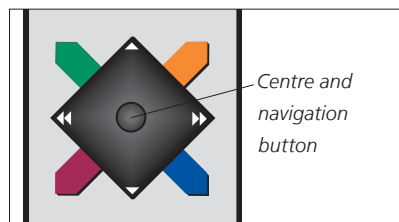

If you have a Beo4 remote control with navigation button, you use the **centre** button with up, down, left and right movement to navigate in menus. Press in the middle of the **centre** button to confirm selections and settings in menus.

To back up through menus, press **BACK**.  
To exit menus, press and hold **BACK**.

Note that your Beo4 remote control must be set to mode 1. For more information, see the Beo4 online guide. You cannot use a Beo4 remote control without navigation button.

Bring up the menu overlay by pressing **MENU** while the television is on.

---

## Beo6

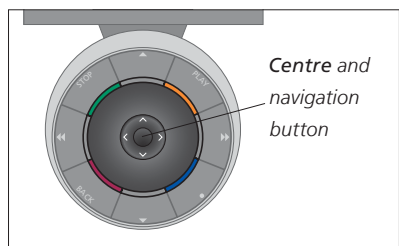

If you operate your television with the Beo6 remote control, you use the **centre** button with up, down, left and right movement to navigate in menus. Press in the middle of the **centre** button to confirm selections and settings in menus.

Bring up the menu overlay by pressing **Menu** while the television is on.

To back up through menus, press **BACK**.  
To exit menus, press and hold **BACK**.

Note that a Beo6 should be reconfigured when you add new products to your setup.

---

## BeoRemote app



Your tablet and your television must be on the same network to use the BeoRemote app.

BeoRemote app allows you to operate your television with a tablet and is especially useful for navigating in web pages or applications using [WebMedia](#).<sup>\*1</sup> Both your television and tablet must be on the same network and WAKE ON WLAN or WAKE ON LAN must be set to ON, see the television NETWORK menu. This allows you to switch on your television from standby mode. Note that the standby power consumption will increase slightly.

BeoRemote app is equivalent to a Beo4 remote control. However, it does not support all Beo4 LIST functions.

Tap on the menu icon (☰) to open the television menu. The navigation pad (⬆️) works as the Beo4 navigation button. Tap in the middle to select a setting. Swipe to the list options to activate television functions.

To back up through menus, tap ↶.  
To exit menus, hold ↶.

BeoRemote has a short built-in guide which describes basic functions (found under SETTINGS).

*Note that first-time setup must be performed using a Beo4/Beo6 remote control. BeoRemote requires that your television is set up in a network.*

<sup>\*1</sup>BeoRemote supports tablets with iOS (most recent iOS version) and Android (3.2 or higher).

# Set positions for the television to turn to

If your television is equipped with the optional motorised stand or wall bracket, you can turn it using the remote control.

Furthermore, you can set the television to turn automatically to face your favourite viewing position when you switch on the television. It can turn to a different position when you listen to, for example, a connected radio, and turn away to a standby position when you switch it off. You can also set up other stand positions for other listening or viewing positions.

If your television is equipped with the motorised stand, you can also turn and tilt it by hand.

## Preset stand positions

Choose one position for when you switch the television on, one for audio mode, and one for when you switch it off. You can also preset stand positions of your own choice, for example, when you sit in an armchair reading or when you sit at the dining table.



Bring up the STAND POSITIONS menu to store, name or delete a stand position.

*If you wish to store the current stand position in an empty stand position field, you just press the **centre** button when you have selected the field. Then you can name the stand position.*

*You cannot rename or delete the STANDBY, VIDEO and AUDIO stand positions. Also you cannot name fields where no stand positions are set. Empty fields are shown by <...>. In some languages, you must choose between predefined names.*

---

## Calibrate the motorised movement

If your setup includes a motorised stand or wall bracket, you will during first-time setup be prompted to calibrate the outer positions of the motorised movement. The motorised movement of the television will not work until the calibration process has been completed. If the television is placed differently later on, for example, in a corner, it may be necessary to calibrate the motorised movement again.

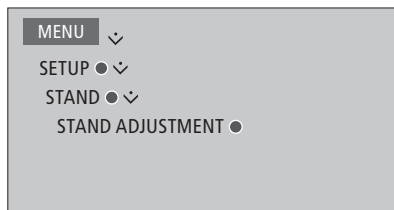

Depending on your setup, you can bring up a menu for stand positions or wall bracket positions.

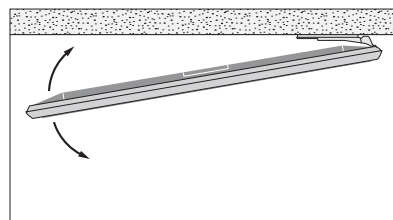
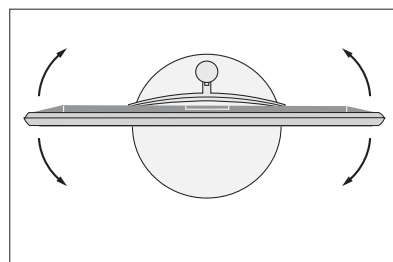

*The calibration process allows you to set the maximum angle the television will turn – left and right.*

# Connections

The connection panel on your television allows you to connect signal input cables as well as a variety of extra equipment, such as a video player or a music system.

Any equipment you connect to these sockets can be registered in the SOURCE LIST SETUP menu. For more information, [see page 13](#).

Before you connect any equipment to your television, remember to disconnect the television from the mains. Except when connecting a source to the HDMI IN or USB socket.

Depending on the type of equipment you connect to the television, different cables and maybe also adaptors are needed. Cables and adaptors are available from your Bang & Olufsen retailer.

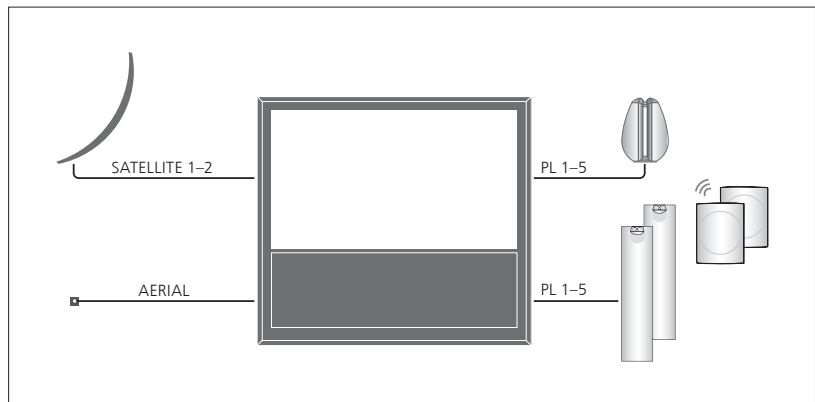

Depending on your tuner options, you may have either one, two, or no satellite inputs.

If you use the optional hard disk recorder, you must use an LNB head with two outputs. If you have more than one satellite dish, you must also use a multi DISEqC switch. For more information, contact your Bang & Olufsen retailer.

### Loudspeakers

Use Bang & Olufsen BeoLab speakers. Cables are available from your Bang & Olufsen retailer.

### *If your television is equipped with a wireless Power Link module ...*

To obtain the best possible wireless connection, it is recommended to place all wireless speakers within a range of 9 metres (29.5 ft) from the television.

Do not place any obstacles in front of the television or wireless speakers, as this may interfere with the wireless connection. The wireless speakers should be placed in one room and be visible from the television. See the guide enclosed with your speaker for information about whether or not your speaker can be connected wirelessly.

### Equipment with HDMI™ output

Equipment with HDMI output such as a set-top box can be connected to any available HDMI socket in the television. For more information on how to set up connected equipment for use, [see page 13](#).

*A configured source can be selected with the configured source button or in the SOURCE LIST. If the television detects an unconfigured source, you are asked to choose between doing nothing, showing the source or configuring it.*

*Connected equipment can be operated with its own remote control or you may download a Peripheral Unit Controller (PUC) table, if available, to use a Bang & Olufsen remote control, [see page 48](#).*

*If you need to reset your television to default settings, then bring up the REGIONAL SETTINGS menu and select another country. You will be asked to confirm the reset. All settings will be deleted and you must go through first-time setup, follow on-screen instructions.*

## Connect digital sources

Connect external HDMI sources, such as a set-top box, computer or game console. All equipment connected to the television can be configured, [see page 13](#).

Depending on the type of equipment you connect to the television, different cables and maybe also adaptors are needed. If you have more than two types of equipment that need a PUC socket, you must buy an extra PUC cable. Cables and adaptors are available from your Bang & Olufsen retailer.

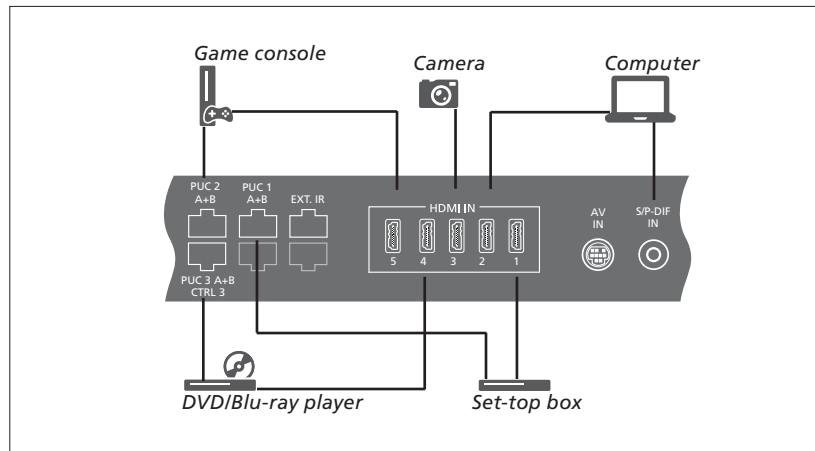

Example of connected digital sources.

### Connect a set-top box

- > Connect the cable to the appropriate socket on the set-top box.
- > Run the cable to an HDMI IN socket on the television.
- > To enable remote control operation of the set-top box, connect an IR-transmitter to one of the PUC sockets and attach it to the IR-receiver of the set-top box. [See page 11 for more information on IR-transmitters.](#)
- > Follow on-screen instructions to configure the source.

### Connect a DVD/Blu-ray player

- > Connect the cable to the appropriate socket on the DVD/Blu-ray player.
- > Run the cable to an HDMI IN socket on the television.
- > To enable remote control operation of the DVD/Blu-ray player, connect an IR-transmitter to one of the PUC sockets and attach it to the IR-receiver of the DVD/Blu-ray player. [See page 11 for more information on IR-transmitters.](#)
- > Follow on-screen instructions to configure the source.

### Connect a game console

- > Connect the cable to the appropriate socket on the game console.
- > Run the cable to an HDMI IN socket on the television.
- > To enable remote control operation of the game console, connect an IR-transmitter to one of the PUC sockets and attach it to the IR-receiver of the game console. [See page 11 for more information on IR-transmitters.](#)
- > Follow on-screen instructions to configure the source.\*<sup>1</sup>

### Connect a camera

- > Connect the cable to the appropriate socket on the camera.
- > Run the cable to an HDMI IN socket on the television.
- > Follow on-screen instructions to configure the source.

<sup>1</sup>\*When selecting GAME CONSOLE as source, the picture mode GAME is activated as default setting. You can change this setting temporarily in the PICTURE menu, [see page 24](#).



## Connect a computer

Before you connect a computer, you must disconnect the television, the computer and all connected equipment from the mains supply.

### Connect a computer

- > Using the appropriate type of cable, connect one end to the DVI or HDMI output socket on your computer, and the other end to an HDMI IN socket on the television.
- > If you use the DVI output socket on the computer, use the appropriate cable and connect the digital sound output on the computer to the S/P-DIF IN socket on the television to hear sound from the computer in the speakers connected to the television.
- > Reconnect the television, the computer, and all connected equipment to the mains. Remember, the computer must be connected to a grounded wall outlet as specified in its setting-up instructions.

---

## Connect an analogue source

You can connect one analogue source, such as a game console or video tape recorder. To configure connected equipment to the television, [see page 13](#).

Disconnect all systems from the mains before you connect additional equipment.

### Connect an analogue source

- > Connect the cable to the appropriate socket on the equipment you wish to connect.
- > Run the cable to the AV IN socket on the television.
- > Reconnect the television and the connected equipment to the mains.
- > To enable remote control operation of the analogue source, connect an IR-transmitter to one of the PUC sockets and attach it to the IR-receiver of the analogue source. [See page 11 for more information on IR-transmitters](#).
- > Follow on-screen instructions to configure the source.

*Different adaptors and maybe also cables are needed. Cables and adaptors are available from your Bang & Olufsen retailer.*

## Connect speakers to the television

You can connect up to ten wired speakers and subwoofers to the television. In addition, you can connect up to eight speakers wirelessly, including subwoofers, if your television is equipped with a wireless Power Link module. For more information about setting up wireless speakers, [see page 20](#).

Disconnect all systems from the mains before you connect additional equipment.

*Depending on the type of equipment you connect to the television, different cables and maybe also adaptors are needed. Cables and adaptors are available from your Bang & Olufsen retailer.*

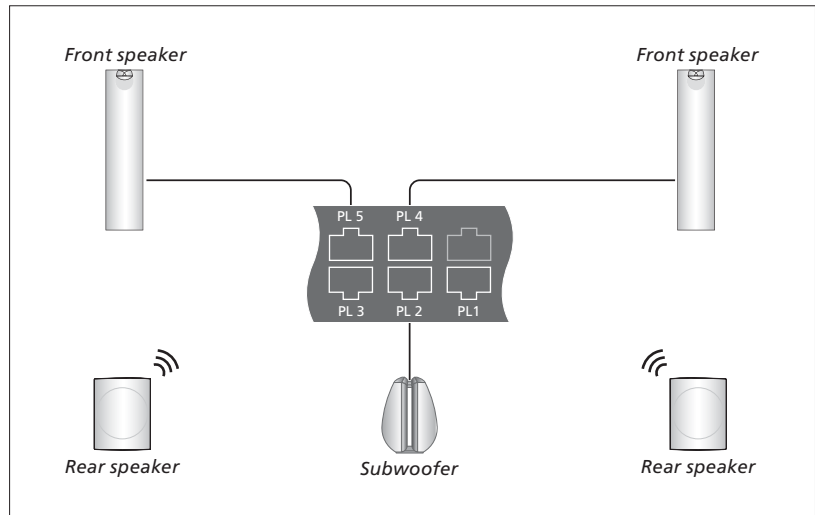

*Example of a speaker setup.*

### Connect speakers

- > Connect a Power Link cable to the appropriate socket on the speakers you wish to connect to the television.\*<sup>1</sup>
- > Run the cables to available sockets marked PL 1–5 on the television.
- > Run a Power Link cable between the appropriate sockets on additional speakers, if available.
- > Connect a Power Link cable to the appropriate sockets on a subwoofer.
- > Run the cable to an available socket marked PL 1–5 on the television.
- > Reconnect the television and the connected equipment to the mains.

*To connect two speakers to one PL socket, a special cable is needed. If it is not possible to loop the cable between two speakers, an extra splitter is needed, contact your Bang & Olufsen retailer for more information.*

<sup>1</sup>*\*Remember to set the switch for left and right position on the speakers.*

## Control

During setup of a source via the SOURCE LIST SETUP menu, you can select how a PUC controlled product is connected. You can choose between PLUG (cable) and IR BLASTER (IR-transmitter). If you select PLUG, you must choose between MODULATION ON and MODULATION OFF. For information about type of cable and modulation settings, contact your Bang & Olufsen retailer.

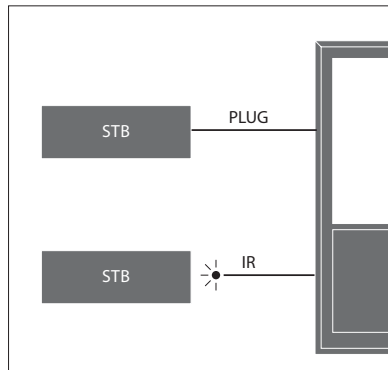

**IR-transmitters:** To operate non-Bang & Olufsen products with a Beo4/Beo6 remote control, attach a Bang & Olufsen IR-transmitter on your non-Bang & Olufsen product and then connect it to one of the sockets marked PUC on the connection panel. Attach the transmitter near the IR-receiver on the connected equipment to ensure remote control operation. Before attaching it, check that you can operate the equipment menus on the television screen using the Beo4/Beo6 remote control.

For an extra PUC cable, contact your Bang & Olufsen retailer.

For information about download of Peripheral Unit Controller (PUC) tables for set-top boxes, [see page 48](#).

---

## Digital channels

If you want to watch coded channels, contact your service provider. The service provider will register you as an authorised viewer, usually requiring payment. You will then be provided with a Smart Card and a CA Module. Note that these will only be valid for one service provider and therefore only work with certain channels.

The CA module is a 'card reader' for your Smart Card which decodes the coded signals sent out by the service provider. Only uncoded digital channels, also known as 'free-to-air' channels, are available without Smart Cards and CA Modules.

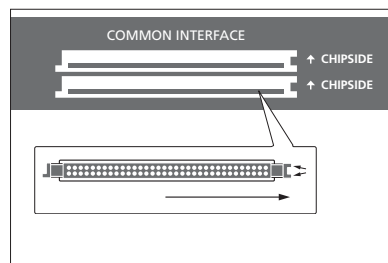

Contact your Bang & Olufsen retailer for information about compatible CA Modules.

The Smart Cards must remain in the CA Modules, unless your service provider asks you to remove it. This is important in case your service provider wishes to send new information to your Smart Card.

Insert a Smart Card carefully into a CA Module. The CA Module has one protruding edge on one side and two protruding edges on the other side. If the television does not receive any signal, check that the Smart Card and CA Modules are inserted correctly.

Smart Cards and CA Modules may also give access to special menus which are not described here. If this is the case, follow the instructions from your service provider.

Continues ...

**Activate the CA modules**

In the CA UNITS menu, you can activate or deactivate the CA modules for terrestrial, cable or satellite. In some countries, it may be useful to disable the CA module for satellite to get an optimal performance from the terrestrial CA module.

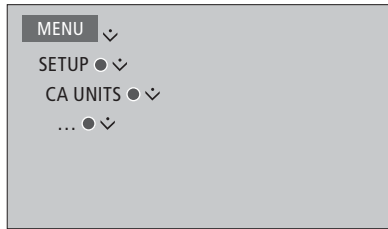

*You can also access the CA modules from the main menu or the Beo6 display when the TV tuner is the current source.*

# Set up additional equipment

If you connect additional video equipment to your television, you can register the equipment via the SOURCE LIST menu.

When the television is switched on and you connect additional equipment to the HDMI IN socket, the television will detect an unconfigured source. A message appears on the screen and you can follow on-screen instructions to configure the source.

Sources have default settings, for example, sound and picture that suit most situations but you can change these settings if you wish. Select the source and select the **ADVANCED SETTINGS** menu.

If your Beo6 remote control has been configured to the sources set up in the television and you change the source button in the television, the source button for the specific source in the Beo6 display will no longer work. Contact your Bang & Olufsen retailer to have your Beo6 remote control reconfigured.

## What is connected?

Registering the equipment connected to the television enables you to operate it with your Beo4/Beo6 remote control.

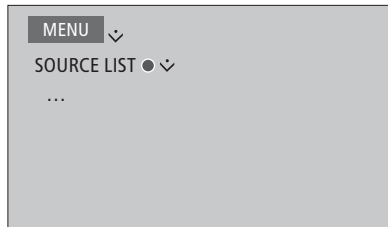

Highlight a source and press the **red** button to set it up. Then you will be asked to name the source and dedicate a button to the source. You can now operate the source.

*When new equipment is detected, a menu is displayed with the following options: DO NOTHING, SHOW SOURCE and CONFIGURE THE SOURCE CONNECTED TO THIS INPUT. If you want to set up the equipment, use the navigation button up or down to highlight the last option and press the **centre** button to bring up a setup menu.*

## Download a PUC table

During the configuration procedure, you are asked if you want to be able to control the connected equipment with your Beo4/Beo6 remote control. Follow on-screen instructions to download a Peripheral Unit Controller (PUC) table if available.\*1 The television must be connected to the Internet.

If your connected equipment is not on the download list, there is currently no control solution for it and you must select **UNSUPPORTED SOURCE**. You will not be able to operate your equipment with your Beo4/Beo6 remote control. Contact a Bang & Olufsen retailer for more information.

*You can search with latin characters and numbers. For equipment names with non-latin characters you can search for a part of the name that includes latin characters. You can also use the browse functions to locate the correct PUC table.*

*\*1If you use a Beo4 remote control, you may have to switch on your IR-controlled PUC equipment using **SHIFT + 9**. **SHIFT** can be found in the Beo4 **LIST**.*

*Continues ...*

## >> *Set up additional equipment*

### **Unconfigure a source**

If you have connected and configured a source to a specific socket on the television and then disconnect the source permanently, you must reset the source settings. Highlight the source in the SOURCE LIST menu, press the **red** button and select RESET TO DEFAULT. When you select YES, the source is no longer configured to this socket. Next time you connect a source to the socket, you are asked to configure the source.

You can also select RESET TO DEFAULT in the ADVANCED SETTINGS menu to reset to default values only for this menu.

To remove the downloaded PUC table, [see page 48](#).

# Use channels, groups and lists

You can make, edit and use groups to make it easier to find your favourite channels and stations.

If automatic tuning of all channels and stations has not stored the channels and stations on your preferred channel numbers, you can rearrange the order in which they appear in a channel or station list. You can also remove or delete channels and stations you no longer wish to have or restore channels and stations you wish to have anyway.

If your country supports Pay Per View channels, you can also order a programme you wish to watch.

*When in Radio mode, the word CHANNEL in menus is replaced with the word STATION. If you want to edit radio station groups, you must switch to a radio source and select EDIT RADIO GROUPS instead.*

## Use and edit channel groups

In the FAVOURITES menu, you can make up to 22 channel groups to find your favourite channels fast without having to go through all tuned channels. For example, you can make a group for each member of the family. You can also name the channel or station groups you have created and delete any group you no longer want. You can also clear a group for channels or stations.



*In a favourites group, you can move a channel to a different position in the list. See the menu on the television screen for instructions.*

### To name and create a favourite group ...

Open the FAVOURITES menu

Press to name/rename a group, for example 'Sports'

Press to store name

Select the now named group

Press to add channels

Select a group to copy from, for example 'News'

Press to select a channel

Press to step in list

Press when you have finished adding channels

Press to store settings

## Channel and station groups

Select a channel group. Channel groups can be groups that you have made yourself or a programme list. Programme lists are sent out by some service providers. They appear and function in much the same way as groups and can be brought up and seen just like groups.

### Bring up an overview of channel groups using a Beo4 ...

Press to bring up an overview of the channel groups



### Step between channel groups using a Beo6 ...

Press to step between groups while watching television. The last activated channel in a group is shown, or ...

... press to bring up an overview of the channel group

*If only one group has been created in the FAVOURITES menu, this group can function as a default list to be brought up after the television has been in standby mode. This assures that the channel numbers are in sync with the Beo6 remote control. For this default list to work, all other lists must be hidden. Press the yellow button to hide/show groups.*

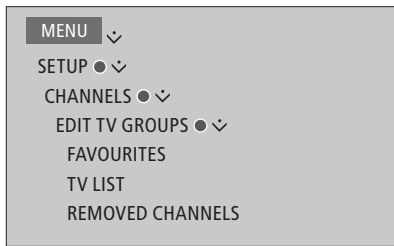

## Channel and station lists

Display a channel list and select a channel.

### *Beo4 operation ...*

Press to select a channel group ●

Press to step between the channels in the group, or ... ◊

... press to bring up the channel positioned at the chosen number in the group 0-9

### *Beo6 operation ...*

Press to bring up a list of channels in the current group Ch list

Press to highlight the desired channel in the group, or ... ◊

... press to bring up the channel positioned at the chosen number in the group 0-9

*Press the **green** button to switch between alphabetical and numerical sorting of the channels and channel groups.*

---

## Edit channels

You can remove any tuned channel or station you do not want in your channel list or restore selected channels that you have removed from your channel list. Only analogue channels can be renamed. This function is not available on all markets.

In the TV LIST menu, you can remove a channel from the channel list. Removed channels can be restored again in the REMOVED CHANNELS menu.

*If you want to edit radio stations, you must switch to a radio source and select EDIT RADIO GROUPS instead.*

*When editing the TV LIST or adding channels to a favourites group, you can press the **green** button to switch between alphabetical and numerical sorting of the channels.*

*Channels that have been removed from the channel list do not reappear when searching for new channels, but are stored in the REMOVED CHANNELS list.*



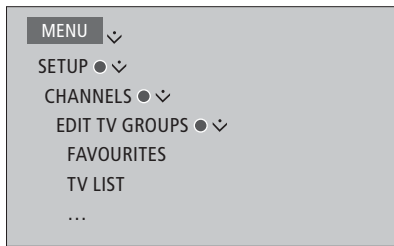

## See channel details

In the TV LIST menu, you can highlight a channel and press the **red** button to see channel details. PARENTAL LOCK is only available if you have enabled ACCESS CONTROL in the setup menu, [see page 44](#). Channels that have a parental lock will be skipped when stepping through channels.

*If the highlighted channel is an analogue channel, you can also rename the channel by means of the **green** button and the navigation button. For some languages, you cannot rename channels.*

*In the TV LIST menu, you can press the **green** button to switch between alphabetical and numerical sorting of the channels.*

*If you want to see details about radio stations or make station groups, you must switch to a radio source and select EDIT RADIO GROUPS instead.*

---

## Watch Pay Per View channels

You can watch Pay Per View channels if supported in your country, however, a subscription is required. The Programme Guide offers information about the channels and programmes. Use this information to order a programme. Contact your service provider for a Customer ID.

### Order a programme ...

Press to select a channel



or

0-9

Follow the on-screen information to get access to a programme. For more information, contact your service provider

# Re-tune channels

You can make your television find your TV channels and radio stations for you.

Depending on your service provider, some settings are made automatically.

## Update channels

You can update tuned channels which, for example, have been moved by the broadcaster.



*If you have tuned in terrestrial channels and more than one network is available, you must also select a preferred network to use.*

*The CABLE, TERRESTRIAL, SATELLITE, and ANALOGUE menu items are only available if they have been activated in the INPUTS menu under the CHANNELS menu. If only one input has been activated, the TUNING menu is skipped and the setup menu for the input is opened directly.*

*Note that when you enter a different service provider or search mode for an input, all lists are cleared.*

## Change channel input settings

Change channel input by enabling or disabling the cable, terrestrial, satellite and analogue inputs, the active antenna and the line length compensation.

You can reinstall all your TV channels by letting the television tune in all the channels automatically.

If you switch to a different network, the channels in your lists may change as well. Only possible if several networks are available when tuning terrestrial channels.

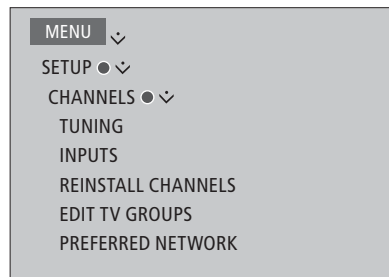

To change a channel input, bring up the INPUTS menu.

To reinstall all channels, bring up the REINSTALL CHANNELS menu.

To select a network, bring up the PREFERRED NETWORK menu.

*NOTE! If you reinstall all your TV channels, all the channel settings you have made disappear!*

For information about the access code, [see page 44](#).

*If you disable an input, all channels and configuration regarding this input are deleted.*

*The PREFERRED NETWORK menu may also appear when tuning in terrestrial channels.*

# Loudspeaker setup – surround sound

Add BeoLab speakers and BeoLab subwoofers to your television wired, or wirelessly if your television is equipped with a wireless Power Link module, and you have a surround sound system which fits easily into your living room. You get the best sound experience in the area bounded by the speakers.

You can also create speaker groups to customise the speaker setup for listening positions other than the one in front of the television, for example, at the dining table or in an armchair.

This guide describes how to make a basic loudspeaker setup.

For more advanced sound settings and adjustments, see the Technical Sound Guide on [www.bang-olufsen.com/guides](http://www.bang-olufsen.com/guides).

For information about daily use of speaker groups, [see page 27](#).

*Your content provider may have prohibited distribution of digital wireless sound to your speakers. You must then use wired Power Link connected speakers instead.*

## Set up the speakers

When setting up wired speakers, you must select which speakers you have connected to each Power Link socket in the **SPEAKER CONNECTIONS** menu. If your television is equipped with a wireless Power Link module it attempts to detect the type of wireless speakers itself, but it is also possible to select which wireless speakers you have connected to each wireless Power Link channel manually.

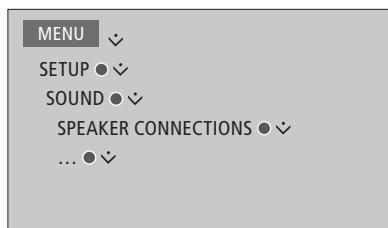



*Important! If you select LINE as speaker type in the **SPEAKER CONNECTIONS** list, the volume will be very loud and you cannot adjust volume with your Beo4/Beo6 remote control. You must use the product's own remote control. LINE is used for, for example, non-Bang & Olufsen amplifiers.*

### Wireless speakers

If you have wireless speakers in your setup, the television automatically scans for wireless speakers and associates the detected speakers with wireless Power Link channels during first-time setup. However, you can also scan for wireless speakers and associate the detected speakers with the television's wireless Power Link channels manually in the **SPEAKER CONNECTIONS** menu.

#### Scan for and associate wireless speakers ...

In the **SPEAKER CONNECTIONS** menu press to rescan 

When the scanning is completed, press to associate the detected speakers with the television 

#### Disassociate a speaker from the television ...

Select a speaker in the **SPEAKER CONNECTIONS** menu 

Press once to be able to disassociate the speaker. Press again to confirm disassociation 

*To be able to reconfigure disassociated wireless speakers, remember to reset the speakers. See the guide enclosed with the speakers.*

Continues ...

If the state of a speaker is *MISSING* in the *SPEAKER CONNECTIONS* menu, the speaker is not detected during a scan, but has earlier been associated with a wireless channel. If you scan again, the speaker can be detected. It then regains its associated state.

## Create speaker groups

You can make different speaker groups for different listening positions or loudspeaker combinations. For each group you must assign roles to the speakers, set the distance between the speakers and your listening position and calibrate the sound level. As you switch between the speakers, a sound is produced alternately in each of the speakers connected in your surround sound setup. Your task is to adjust the sound level from all the connected speakers to match the sound level of the other speakers in the group.

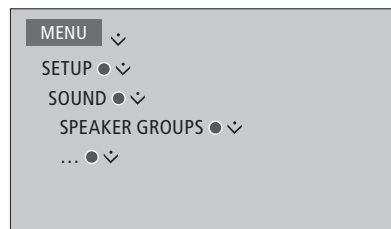

You can also name the speaker groups or delete groups you do not want to keep. The TV speaker group is a predefined group you can set up for when you sit in front of the television.

Assigning roles to the connected loudspeakers allows you to specify the speakers' function in a surround sound system and the number of speakers to be used.

Press the **red** button to activate the speaker group if you have highlighted TV or an existing group.

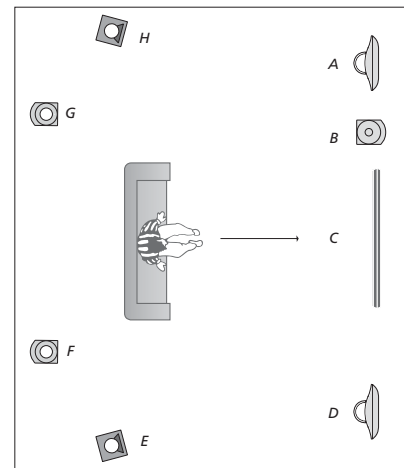

Example of TV viewing illustrated ...

Speaker A:	Left front
Speaker B:	Sub front
Speaker C:	Centre
Speaker D:	Right front
Speaker E:	Right surround
Speaker F:	Right back
Speaker G:	Left back
Speaker H:	Left surround

You cannot rename or delete the TV speaker group. [See page 27 on daily use of speaker group.](#)

To make more advanced settings for speaker group setup, see the Technical Sound Guide on [www.bang-olufsen.com/guides](http://www.bang-olufsen.com/guides).

Continues ...

## Set up sound modes

The television has several sound modes optimised for different types of programmes. However, if you wish, you can adjust the values in the sound modes to your liking. The sound modes have predefined names. For example, use MOVIE when watching from a DVD or Blu-ray or use GAME to enhance the sound when using a game console. The CUSTOM sound mode can be set up if you wish to define a new type of use and settings. It is the only mode you can rename. The ADAPTIVE sound mode is not a mode in itself but adapts to the selected source or the content by selecting between several sound modes.

For more details or to make more advanced settings for sound modes, see the Technical Sound Guide on [www.bang-olufsen.com/guides](http://www.bang-olufsen.com/guides).

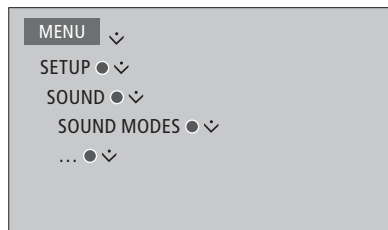

If you wish to reset a sound mode to default values, you must select **RESET TO DEFAULT** in the specific sound mode's setup menu and confirm that you wish to reset the values.

With Beo4 you can bring up a list of sound modes on the television screen by finding **SOUND** in the Beo4 **LIST** menu and pressing the **centre** button. From here, you can select a sound mode with the number buttons. [See page 26 on daily use of sound modes.](#)

# Adjust sound and picture settings

Sound and picture settings are preset from the factory to neutral values which suit most types of programmes. However, if you wish, you can adjust these settings to your liking.

Adjust sound settings such as volume, bass and treble and, for wired speakers, enable eco mode. Picture settings include, for example, contrast, brightness, colour, and viewing distance.

Change your sound and picture settings temporarily – until your television is switched off – or store them permanently.

Activate different picture modes, for example, game mode if you connect a game console to your television.

For information about how to change the picture format, see Getting Started.

## Adjust sound settings

Adjust sound settings via the **SOUND** menu. Temporary settings are cancelled when you switch off the television.

If you choose to enable eco mode, all wired speakers in a speaker group that do not receive a signal will switch off and save power.

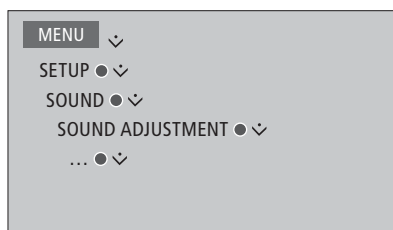

*In the **AUDIO DESCRIPTION** menu, you can set the television to describe what happens on the television screen by means of sound. Remember to enable the **VISUALLY IMPAIRED** menu field in the **LANGUAGES** menu under **REGIONAL SETTINGS**.*

---

## Adjust picture settings

Adjust the picture settings via the **PICTURE** menu. Temporary settings are cancelled when you switch off the television.

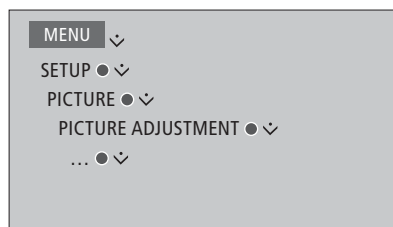

*To temporarily remove the picture from the screen, press **LIST** and use the navigation button up or down to bring up **P.MUTE** in the Beo4 display and press the **centre** button. To restore the picture, press a source button. (Beo6: press **△** to bring up the Scene display on Beo6, press **Picture**, then press **P.Mute**. To restore the picture, press **P.Mute** again).*

## Picture modes

You can activate different picture modes to use for different types of programmes. If you, for example, connect a game console or play a PC game using the television as a monitor, you can activate GAME mode. GAME mode minimises the delay caused by signal processing. Other available picture modes are MOVIE and ADAPTIVE. When you select a picture mode for a source through the PICTURE menu, it is only saved until you switch off the television or switch to a different source.

When you configure a source, you can set a picture mode to be selected automatically each time you switch on the source. The setting is made in the ADVANCED SETTINGS menu under the SOURCE LIST SETUP menu.

*To activate picture modes with Beo4 directly ...*

Press to bring up PICTURE in the Beo4 display

LIST



PICTURE



Press to select a picture mode

1-3

Step between modes



Press and hold to remove PICTURE from the display

BACK

*To activate picture modes with Beo6 directly ...*

Press to bring up the Scene display on Beo6



Press to bring up the Picture ... display

Picture ...

Press the picture mode you want, for example 'Movie'

Movie

Press to remove the Picture mode display and return to the source you were using



*To adjust picture modes via the television menu ...*

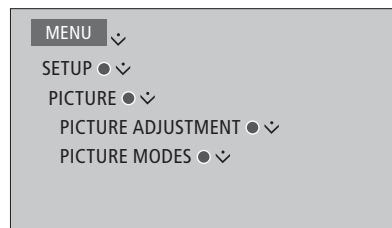

*In the PICTURE ADJUSTMENT menu, you can bring up an ADVANCED SETTINGS menu where you can make different settings for the selected source. For example, you can reset picture settings. Press the blue button to bring up help texts for the menus.*



# Set up 3D television

You can set up preferences for watching 3D television. Select if the television should switch to 3D mode automatically, when automatic 3D signalling is available.

## Activate 3D and adjust settings

You can select if the television should activate 3D mode automatically, manually or by prompt, when it detects automatic 3D signalling the first time after source or channel change. The default setting is PROMPT.

*When automatic 3D signalling is available, and ACTIVATE 3D is set to AUTO, the television switches to 3D mode automatically. If it is set to PROMPT, you must select between VIEW IN 3D and VIEW IN 2D. If it is set to MANUAL, you must enter the menu and switch to 3D mode manually.*

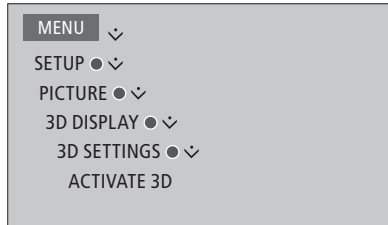

To activate 3D, bring up the ACTIVATE 3D menu and follow on-screen instructions.

# Daily use of sound modes and speaker groups

You can extend your television into a surround sound system by adding BeoLab loudspeakers and subwoofers.

When you switch on one of the sources, the television automatically selects the appropriate sound mode for the source you are using. However, you can select another sound mode at any time.

Also when you switch on the television, the TV speaker group is selected automatically. However, you can always select another group of activated speakers if you want to listen to music without having to sit in front of the television, for example, when you sit at the dining table or in an armchair.

You can adjust the settings of the sound modes and set up speaker groups. For information about setting up sound modes and creating speaker groups, [see pages 21–22](#).

## Select a sound mode

You can select the sound mode that suits the source you are using.

### Beo4 operation ...

Press to bring up **SOUND** in the Beo4 display

LIST



SOUND



Press to select the sound mode you want

1 – 9

Step between modes



Press to remove **SOUND** from the Beo4 display

BACK

### Beo6 operation ...

Press to bring up the Scene display on Beo6



Press to bring up the Sound display

Sound ...

Press to select the sound mode you want, for example

Adaptive

### Adaptive

Press to remove the Sound mode display and return to the source you were using



*When you configure a source, you can set a sound mode to be selected automatically each time you switch on the source. The setting is made in the **ADVANCED SETTINGS** menu under the **SOURCE LIST SETUP** menu.*

## Select a speaker group

Select the speaker group that suits your listening position.

### Beo4 operation ...

Press to bring up **SPEAKER** in the Beo4 display

LIST



SPEAKER



Press to select the speaker group you want. The selected speakers cut in automatically

1 - 9

Step between groups



Press to remove **SPEAKER** from the Beo4 display

BACK

### Beo6 operation ...

Press to bring up the Scene display



Press to bring up the Sound ... display

Sound ...

Press to bring up the Speaker groups display

Speaker groups

Press to select the speaker group you want. The selected speakers cut in automatically

1 - 9

Press to remove the Speaker group display and return to the source you were using



## See two sources at the same time

Your Beo4/Beo6 remote control gives you access to a dual-screen function for viewing two video sources at the same time. You can also bring up a video source and an audio source at the same time. For example, you can view a video playback and a TV programme at the same time, provided that the selected sources are available in your system.

*There are some limitations when using the Picture-and-Picture (P-AND-P) function since some source combinations may not be possible. For example, you cannot watch two HDMI sources or two coded channels at the same time. When an invalid combination is selected, an on-screen message appears on the television screen.*

*If you watch 3D and switch on the P-AND-P function, the television will switch to 2D.*

*To view a source registered in the SOURCE LIST SETUP menu as V.AUX, such as a set-top box, press LIST and use the navigation button up or down until P-V.AUX is shown in the Beo4 display.*

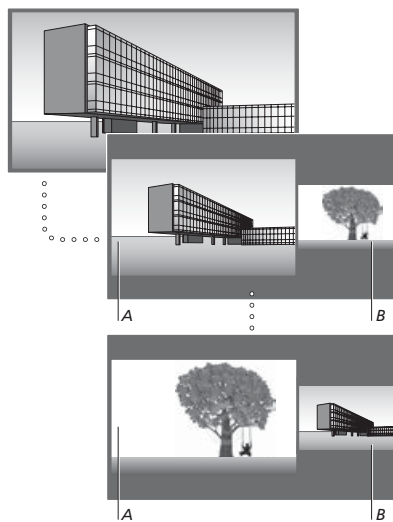

*Volume adjustment always affects picture A, while other operations, such as selecting channels, affect picture B. Selecting a new source cancels P-AND-P viewing.*

*While watching, for example, television ...*

### **Beo4 operation ...**

Press to bring up P-AND-P

LIST



P-AND-P



Press, for example, DVD to select the source to view on the right side of the screen (B)

DVD

Press to swap the left picture and right picture

MENU

0

Press to bring up P-AND-P to switch between small and large for the left and right picture

LIST



P-AND-P



### **Beo6 operation ...**

Press to bring up the P-and-P display

P-and-P

Press, for example, DVD to select the source to view on the right side of the screen (B)

DVD

Press to swap the left picture and right picture

Swap

Press to switch between small and large for the left and right picture

Size

### **To leave the P-AND-P function ...**

To leave the function and return to normal viewing of the source on the left side of the screen (A) simply select a source

# Programme information

You can bring up information on the current programme, or bring up a Programme Guide. You can also change audio and subtitle language or bring up interactive information via HbbTV.

An information display appears briefly on the screen every time you change channel or station. You can also bring up a display manually by pressing the **blue** button to see programme information.\*<sup>1</sup>

<sup>1</sup>\*If Digital Text/HbbTV is enabled, you must press **MENU** before the **blue** button on Beo4.

HbbTV may not be available on all markets.

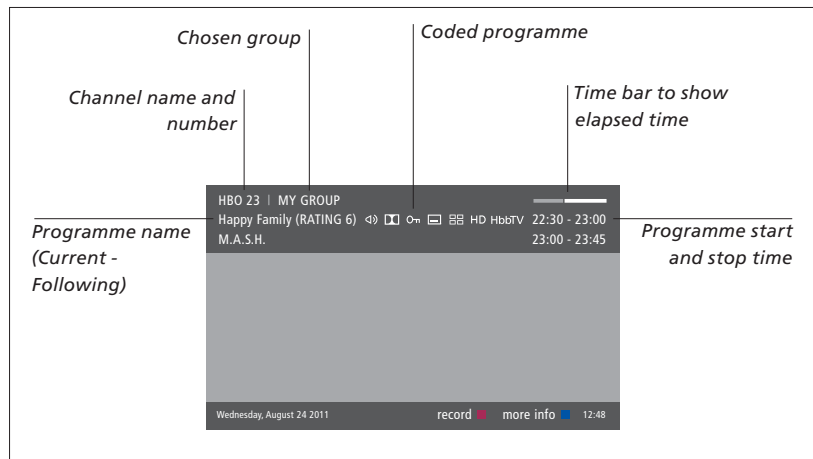

To see more programme information, press the **blue** button while the television display is shown.\*<sup>1</sup> Use the arrow buttons to navigate back and forth in time and channels and the **centre** button to select the current channel. Press **BACK** to leave programme information. On Beo6, press **Information** on the Beo6 display.

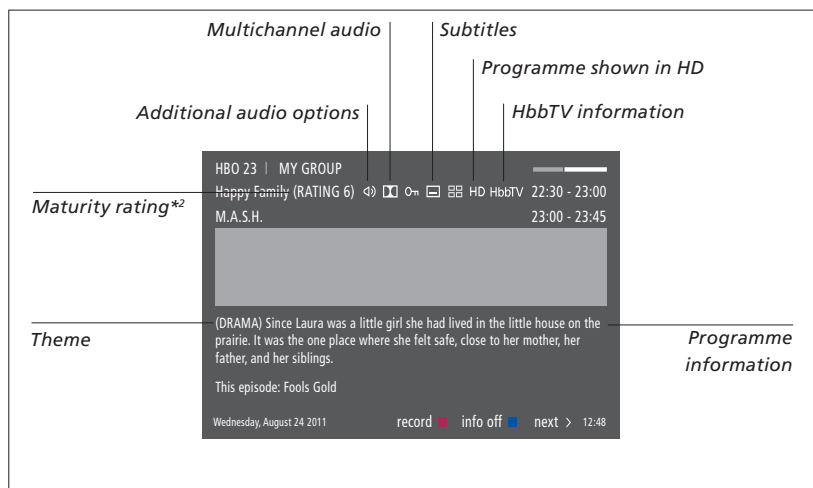



When the extended display is shown on the screen and the information exceeds one page, you can scroll down the page using the navigation button down.

Subtitles and additional Audio options are shown by the icons at the top. Note: This service is not offered by all channels.

<sup>2</sup>\*Maturity rating is only visible if available from your service provider.

## Subtitles and audio options

The icons  and  indicate that either additional audio or subtitle options are available.

### Beo4 operation when no menu is shown on the screen ...

Press to bring up the SUBTITLE LANGUAGE menu, or ... 

... press to bring up the AUDIO LANGUAGE menu 

Also, the audio options may have the extension AC3 or AAC, for example, English AC3, which indicates different sound systems.

### Beo6 operation when no menu is shown on the screen ...

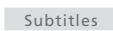
Press to bring up the SUBTITLE LANGUAGE menu, or ... 

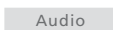
... press to bring up the AUDIO LANGUAGE menu 

AUDIO LEFT and AUDIO RIGHT allow you to direct left or right audio to the front speaker.

---

## Programme Guide

You can bring up a Programme Guide that contains information about current and coming programmes on channels and stations for up to two weeks. You can also change to a different channel or station via the Programme Guide. You cannot bring up a Programme Guide for analogue channels and stations.

Press the **green** button to bring up the Programme Guide. On Beo6, press **Progr. Guide**.

*Note that sound may be muted while the Programme Guide is updated.*

*The Programme Guide language will be the selected menu language if available. Otherwise it will be the language available through the TV signal.*

### From the Channel Programme Guide ...

Press to bring up information on a specific programme 

Press twice to select a highlighted programme 

Press and hold to remove information from the screen 

Press to return to the Programme Guide – Overview\*<sup>1</sup> 

*Pressing the yellow button while a channel is highlighted in the Programme Guide allows you to select another group.*

*<sup>1</sup>If HbbTV is enabled on the channel, the coloured button might not work.*

### From the specific programme information ...

Press to select the channel 

Press to return to the previous level 

Press and hold to remove information from the screen 

## HbbTV

HbbTV (Hybrid Broadcast Broadband TV) is an online service where you can access a wide variety of services, such as catch-up TV, competitions, interactive advertisements and social networking. To view the information, your television must be connected to the Internet.

You can choose to block HbbTV per channel if you do not wish to use this feature.

*HbbTV is not supported by all markets and the content supplied depends on the broadcaster. Also content might be blocked by some broadcasters.*

### Activate HbbTV ...

When HbbTV is available, press the coloured button indicated on the screen



### To block HbbTV using a Beo4 ...

While on the channel, press to bring up HBB TV menu



Use the navigation button left and right to select ON or OFF to block HbbTV



### To block HbbTV using a Beo6 ...

While on the channel, press to bring up HBBTV menu and follow on-screen instructions



Use the navigation button left and right to select ON or OFF to block HbbTV



# Record a programme

The optional hard disk recorder allows you to make Timer recordings and execute two Timers simultaneously. Your stored Timers are listed in the TIMER INDEX. Here you can edit or delete your Timers.

You can also copy a programme from the timeshift buffer to the hard disk to keep it.

To ensure that your Timers are executed correctly, set the built-in clock to the correct time and date.

The optional hard disk recorder menus offer options for settings and adjustments. Bring up the RECORDING SETTINGS menu and follow on-screen instructions. Also press the **blue** button to bring up help texts.

**It is only possible to record from digital channels.**

*You cannot record a programme from a radio station.*

## Make a Timer recording

Set a Timer in the **TIMER PROGRAMMING** menu. Here you select the source to be recorded, the programme's start time, the stop time and the date or days of the week that the programme is shown.

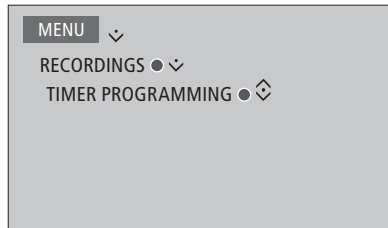

To set a Timer, bring up the **TIMER PROGRAMMING** menu.

You can record from the optional hard disk recorder's own tuner and from the television tuner while playing a recording. You can also record a programme to the hard disk content and at the same time save a programme to the timeshift buffer. There might be some limitations regarding recording and timeshift. For more information, see Getting Started and the following pages.

You can also start to play a recorded programme even though recording of the specific programme is still in progress. Note that you cannot record copy-protected programmes. For information about making a manual recording here and now, see Getting Started.

*KEEP EPISODES is only available when DATE is set to DAYS and PROTECTION is set to OFF.*

*If the Timer index is full, the **TIMER PROGRAMMING** menu is inaccessible.*

*If a Timer recording, for some reason, is not successfully completed, you are notified if the same programme is found in the Programme Guide for you to make a new Timer.*

*If a Timer recording is programmed from the Programme Guide or the information display, it is only possible to change the protection, category and parental lock status.*

*If a recorded programme is split into two events, for example, due to a news programme, both events are recorded. However, this requires that there is less than three hours between the start and stop time of the recordings and that the Programme Guide recognises that the two programmes are related.*

*Continues ...*

*In some countries, it is not possible to record a CI+ programme while watching another programme.*



## >> Record a programme

### Record using the Programme Guide...

Press to bring up the Programme Guide and select the programme you want to record



Press to be able to start a recording.



Press to start recording of the selected programme. The programme is now underlined. Or, ...



... if the programme is part of a weekly series, press to programme a repeated Timer recording



The Timer PROGRAMMING menu is shown, and you can use the navigation button and number buttons to edit the Timer recording



Press to save the Timer recording. The programme is now underlined



Highlight the programme again and press to bring up recording options (delete or cancel)



After the recording has finished, it is saved in the HARD DISK CONTENT menu.

*Two recordings can be recorded at the same time but if you try to record a third programme an on-screen menu appears.*

### About space management and protection

The television has a space management feature which, when necessary, automatically makes space for manual and timed recordings. It does so by deleting the required amount of content from the optional hard disk. The following principles apply:

- Protected recordings are never deleted.
- Recordings that have been viewed or edited are deleted before recordings that have not been viewed or edited.
- The oldest recordings are deleted first.
- A recording is not deleted automatically when it is in playback mode.
- Timed recordings are not executed if the optional hard disk is full and all recordings are protected, and any recordings in progress are stopped automatically when the hard disk capacity is reached.

*Recordings with a limited lifetime, such as rented recordings, are deleted automatically, when they expire. These recordings are indicated by |EXPIRES after the recording name. If time information for a recording that will expire is not valid, it is not possible to play back this recording. When you watch a recording and it expires, you are informed by an on-screen message that can be removed by pressing the **centre** button.*

*You are notified if there is no more space or too little space left on the optional hard disk recorder for a Timer recording.*

*Continues ...*

>> Record a programme

## Check the Timers already set

You can check the Timers that are waiting to be executed, as well as edit or delete them. You can also disable a Timer either once or indefinitely if a repeating Timer overlaps with another Timer.

*If you edit a disabled Timer, it is automatically enabled again.*

*When creating Timer recordings and the maximum capacity of Timer recordings approaches, you are notified in the menus.*

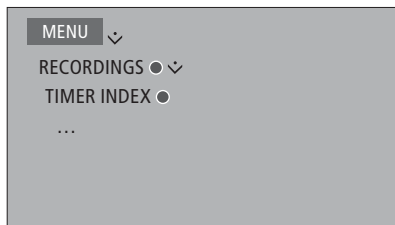

## Copy from the timeshift buffer

The timeshift buffer is a temporary storage. If you change source, channel or station, or if you switch off the TV, the buffer content is deleted. To keep a recording, you can copy it from the timeshift buffer to the HARD DISK CONTENT menu by making a manual recording. If you start a manual recording during timeshift, the recording starts from the start time of the programme. If you switch channel after a programme has started, the recording will start from there. For more information, see Getting Started.

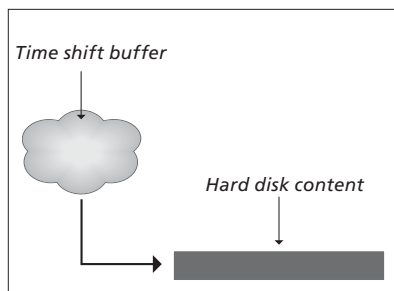

*NOTE! The programme provider may have some restrictions on what can be recorded or timeshifted. The recorded programme may also be available for a limited time period. Contact your programme provider for information about recording policy.*

### Copy to the hard disk...

Press to pause timeshift



Press to start playback



Press to cue backwards to you see the programme you want to record



Press to start recording to the hard disk.\*<sup>1</sup>



*The content before the recording start time will be deleted.*

*<sup>1</sup>If a manual recording is started during timeshift, the part of the timeshift that belongs to the programme will also be a part of the new recording.*

*After copying from timeshift to the HARD DISK CONTENT menu, you can edit the new recording, as you can edit any other recordings.*

# Edit recordings

The optional hard disk recorder allows you to edit the hard disk content to your liking. For example, you can change category of a channel recording or delete, shorten, or split it into two separate recordings.

In addition, you can protect any recording you wish to keep or activate a Parental Lock.

Bring up the main menu and select RECORDINGS to bring up the HARD DISK CONTENT menu. Here, among other things, you can sort your recordings alphabetically or by date using the **green** button.

If Parental Lock is activated for a recording, you must enter the Access Code before you can bring up the OPTIONS menu and edit the recording.

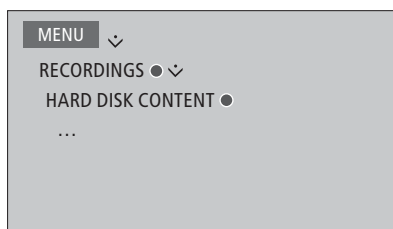

You can prevent access to your recordings by activating the Parental Lock function. This requires that you first enter a Parental Lock code. The ACCESS CONTROL menu allows you to set a code that limits access to your recordings. To set the Parental Lock code, [see page 44](#).

### *Change name of a recording ...*

If you wish to change the name of a recording, for example, if you have made a manual recording, you can give it a new name in the HARD DISK CONTENT menu. Follow on-screen instructions.

### *Divide a recording ...*

You can divide a single recording into two. This can make it easier for you to find, for example, a particular scene when browsing through a long recording. Follow on-screen instructions.

*Note: For some languages, you cannot set a name.*

### *Trim a recording ...*

You can trim away a section of a recording. Simply select a point in the recording and specify whether you wish to delete the section of the recording before or after this point. You cannot delete a section in the middle of the recording. Follow on-screen instructions.

### *Delete a recording ...*

At any time, you can delete a recording you do not want, including protected recordings. You can also delete all recordings within a category or a view. Follow on-screen instructions.

*A protected recording will be indicated by |KEEP after the name.*

*All recordings that have an expiration date are automatically protected until they expire. These recordings are indicated by |EXPIRE after the name, and it is not possible to deactivate protection for these recordings.*

*Names and protection are unaltered for the new recordings, but if you split or protect a recording which is part of the KEEP EPISODES feature, this specific recording will no longer be a part of this feature.*

# WebMedia

With the built-in WebMedia feature you can search and find movies, YouTube videos, photos and other web related content. WebMedia enables integration of Internet features on your television. You can also add different apps. To use WebMedia, your television must be connected to the Internet, [see Network settings](#).

The first time you open WebMedia you are asked to accept the terms of use. If you reset your television to default settings, you must accept the terms of use again. If you want to be able to lock selected apps, you can make your own pin code at this point.

You can also operate WebMedia with BeoRemote app, [see page 5](#) for more information.

WebMedia may not be available on all markets.

## Activate WebMedia

Press to activate the source button dedicated to WebMedia, for example, DTV\*<sup>1</sup>

<sup>1</sup>\*You can also bring up the main menu, select SOURCE LIST, highlight WEBMEDIA, and press the **centre** button to activate the source.

## Basic navigation ...

Press to navigate in the Internet browser, available apps, or on the keypad when available

Press to accept or select

Press to go back one level, long press will bring up the WebMedia home screen

## Navigate in an Internet browser ...

Press to step in web page history

Press to move the web page up or down for easy navigation

DTV



BACK



## Add an app ...

Open the App Gallery

Select a country\*<sup>2</sup>

Add the app by following on-screen instructions. Go to the WebMedia home screen to find the added app.

## Lock/unlock an app ...

You can restrict access to certain apps by locking them with a pin code. While the app is highlighted, press to lock/unlock it

Enter the WebMedia pin code (not the television pin code)\*<sup>3</sup>

Accept the code



0-9



Continues ...

<sup>2</sup>\*You can add apps from different countries. However, some apps might be blocked by the broadcaster.

<sup>3</sup>\*If you did not select a pin code, the first time you activated WebMedia, you are asked to set a pin code before you can lock the app.

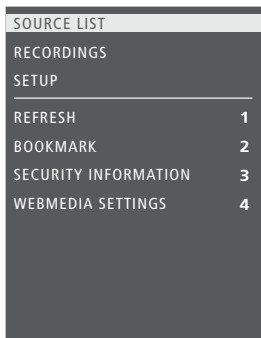

While WEBMEDIA is selected as source, press **MENU** to bring up the WebMedia menu overlay. The remote control buttons are shown to the right on the menu, and the functions they control are shown to the left.

#### ***Refresh a page ...***

You can refresh a page if it is updated frequently, such as the weather forecast or online newspapers.

#### ***Add a bookmark ...***

While on a web page, press **MENU** to bring up a menu overlay. Press **2** to add a bookmark for that specific website.

*Added bookmarks are stored in the Internet application. Go to the WebMedia home screen and select the Internet app to see the added bookmark.*

#### ***Check page security information ...***

Using the security information menu, you can check the URL of the website and retrieve security information.

#### ***Change NOW ON TV source ...***

NOW ON TV shows a preview of what is shown on the selected source. For example, if you have selected HDMI 1 as your source and you have a set-top box connected, you will get a preview of the current programme. The source is selected in the WEBMEDIA SETTINGS menu.

# HomeMedia

You can play music and video files and browse photos stored either on a storage device or in another product connected via a DLNA/UPnP enabled media server. You get access to the HOMEMEDIA menu when you connect a storage device to your television.

If you have music and photos stored, you can start the music and return to the main menu to start a slideshow of your photos. You can then play music and see your photos at the same time.

Storage devices include, for example, USB devices and regular hard disks connected via USB or Ethernet.

For supported formats, see [www.bang-olufsen.com/guides](http://www.bang-olufsen.com/guides).

## Use HomeMedia

During playback of your music, you can see the NOW PLAYING menu with cover and information about artist, title and track, if available. When you browse or play your music, photo and video files, you can press the **blue** button to bring up additional information.

### Listen to music ...

Connect a storage device with your music

Press to activate the source button dedicated to the media browser, for example, **H.MEDIA**\*<sup>1</sup>

Press to select the storage device with your music and press the **centre** button

If the storage device is a media server, press to highlight the music or folder menu and press the **centre** button

Press to browse your files and folders and press the **centre** button to open the folder or start playback of the file

Press to step in tracks during playback. Press and hold to cue during playback. Press again to change cue speed\*<sup>2</sup>

Press to step in tracks during playback.

Press to pause

Press to resume playback

Press to back up through previous menus or press and hold to return to the main menu

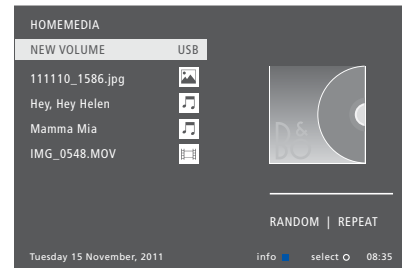

You can also bring up the NOW PLAYING MUSIC by pressing **MENU**, then the **red** button. On Beo6, press **Music**.

<sup>1</sup>\***H.MEDIA** is in the Beo4 **LIST**. You can also bring up the main menu, select **SOURCE LIST**, highlight **HOMEMEDIA**, and press the **centre** button to activate HomeMedia.

<sup>2</sup>\*During photo slideshows or video playback, you cannot step in tracks or pause in music files.

Continues ...

**Browse photos ...**

Connect a storage device with your photos

Press to activate the source button dedicated to the media browser, for example, **H.MEDIA**\*<sup>1</sup>



Press to select the storage device with your photos and press the **centre** button



If the storage device is a media server, highlight the photo or folder menu and press the **centre** button



Press to browse your files and folders and press the **centre** button to open the folder



Press to open your photo in full screen view. The slideshow starts automatically



Press to pause the slideshow



Press to continue the slideshow



Press to step to the previous or next photo, also in pause mode



Press to step to the previous or next photo



Press to bring up information on the current photo. (Beo6: Press **Information**)



Press to exit a slideshow and return to browser screen or back up through previous menus or press and hold to return to the main menu



To rotate a photo left or right, press **MENU** then **2** or **3** or use the navigation button left or right. On Beo6, press < **Rotate** or **Rotate** >.

You can also bring up the **NOW SHOWING PHOTO** by pressing **MENU**, then the **green** button. On Beo6, press **Photo**.

<sup>1</sup>**H.MEDIA** is in the Beo4 **LIST**. You can also bring up the main menu, select **SOURCE LIST**, highlight **HOMEMEDIA**, and press the **centre** button to activate HomeMedia.

**Play back video files ...**

Connect a storage device with your video files

Press to activate the source button dedicated to the media browser, for example, **H.MEDIA**\*<sup>1</sup>



Press to select the storage device with your video files and press the **centre** button



If the storage device is a media server, highlight the video or folder menu and press the **centre** button



Press to browse your files and folders and press the **centre** button to open the folder or start playback of the file



Press to pause



Press to resume playback



Press to step minute by minute. Press and hold the buttons to cue. Press again to change cue speed



Press to step in files during playback.



Press to go to a specific point in time in the file



Press to exit video playback and return to browser screen or back up through previous menus or press and hold to return to the main menu





You can also bring up the **NOW PLAYING VIDEO** by pressing **MENU**, then the **yellow** button. On Beo6, press **Video**.



### See a list of recently selected files

You can see a short list of the files you have recently selected from the currently connected storage devices.

Press the source button  dedicated to the media browser to activate it, for example, **H.MEDIA**.<sup>\*1</sup> The recently selected files are listed beneath the list of detected storage devices

Press to highlight a file you wish to play back and press the **centre** button  

To clear the list of recent selections, press **MENU** and then **1**. On Beo6, press **Clear History**.

<sup>1</sup>***H.MEDIA** is in the Beo4 LIST. You can also bring up the main menu, select SOURCE LIST, highlight HOMEMEDIA, and press the centre button to activate HomeMedia.*

### Make media settings

You can choose to play your music files or browse your photos in a random order or repeat playback, or browse when you have been through all music files, photos or video files. You can also set a slideshow delay to determine for how long each photo is displayed before the next photo is brought up.

To bring up the SETTINGS menu, press **MENU** and then **4**. On Beo6, press **Settings**.

*During rotation of a photo, the slideshow delay timer is reset.*

*You can also find HOMEMEDIA if you bring up the main menu and select the SETUP menu.*

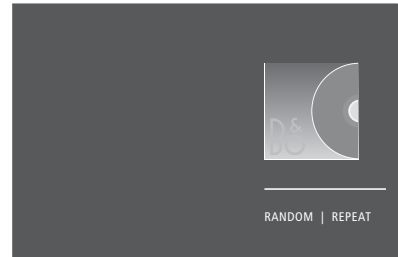

*Example of player mode.*

If you do not operate HomeMedia for approx. 30 seconds, it will go into player mode where only the NOW PLAYING information is shown. Press **BACK** to bring back the browser list on the screen. You can also activate player mode manually by pressing **BACK** while the HomeMedia main menu is shown.

# Sleep Timers

Your television has a built-in Sleep Timer which means that you can make it switch off after a predefined number of minutes.

## Set a Sleep Timer

You can make the television switch off automatically after a number of minutes.

*To activate the Sleep Timer with Beo6 ...* Press repeatedly to select the  number of minutes or **Off**

*To activate the Sleep Timer with Beo4 ...*

Press to bring up **SLEEP** in the Beo4 display\*<sup>1</sup>



Press repeatedly until the requested number of minutes or **OFF** are shown in the television display.

*<sup>1</sup>In order to display SLEEP on Beo4, you must first add it to the Beo4 list of functions.*

# Power settings

If you want to make your television start up faster, you can set a Quick-Start Timer for one or two specified time periods. This will increase the standby power consumption within these periods compared to when the television is in ordinary standby.

On the other hand, you can choose to save power on a number of other functions in the television, such as sound, picture and network. When you set up power saving for the picture, a preview shows you the picture quality for each option which makes it easier for you to select the combination of power consumption and quality that suits you best.

In the AUTO STANDBY menu, you can set the television to switch off automatically after some time without operation.

## Set up the power consumption

Set up the power consumption for standby, sound, picture, and network. The television can be set to switch itself to standby after some time without operation. The factory setting is 4 hours. This function only applies in video mode, not in audio mode.

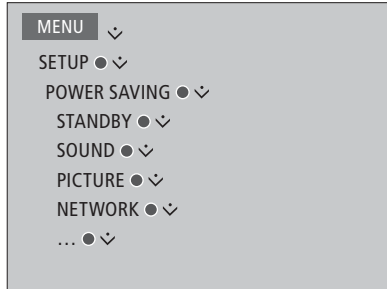

To reduce the start-up time or set up auto standby, bring up the STANDBY menu.\*<sup>1</sup>

To make power saving settings for sound, bring up the SOUND menu.

To make power saving settings for picture, bring up the PICTURE menu.

To make power saving settings for network, bring up the NETWORK menu.

*When AUTO STANDBY is activated, a message appears on your television screen if the television has not been operated during the time set in the menu. The television then switches to standby if you do not operate it.*

*When no source signal has been detected for 15 minutes, the television switches to standby.*

*<sup>1</sup>If a Quick-Start Timer is active, your television will switch on within seconds. If you receive your television signal from a connected set-top box, the television start-up time is also affected by the start-up time of the box. Setting a Quick-Start Timer will increase the power consumption within the specified period.*

# Access control

The ACCESS CONTROL menu allows you to activate a parental lock to be able to lock specific channels. You can also set a maturity rating that determines which programmes require that you enter an access code.

When you bring up a channel list, you can lock and unlock channels to prevent others from watching these. If you lock a channel in the main list, it will be locked in all the channel groups in which it is present as well. When you try to access a locked channel, you are asked to enter the access code.

The access control system is not the same as the pin code system for the television, but it may be easier for you if you choose the same code for both systems.

Also, the access code described here is not the same as the pin code you have received with your Smart Card. For information about Smart Card pin code, contact your service provider.

## Set up the access control system

Enable the access code so you can lock channels and prevent others from editing channel lists. You can also set a maturity rating to limit access to certain programmes exceeding the chosen rating if rating information is available from the service provider.

You can always change the access code. The first time you bring up the ACCESS CONTROL menu you are asked to select a new access code.

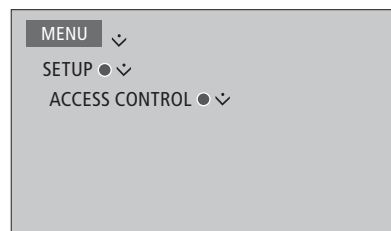

*On some markets, it is not possible to disable access control for programmes rated 18 years and you must enter the access code every time you bring up such a programme.*

*On some markets, it is not possible to select the access code '0000'.*

### ***Should you forget your code ...***

If you forget your access code, bring up the ACCESS CONTROL menu and press '9999' three times. The access control system is then disabled and you must enable it again and enter a new access code. Note that disabling the access control system is prohibited by some programme providers.

# HDMI Matrix

The HDMI Matrix itself is a physical product that can be connected allowing you to connect up to 32 external sources to up to 32 televisions in different rooms and access the sources either individually from each TV or simultaneously from several rooms via the Beo4/Beo6 remote control.

**The HDMI Matrix must be connected and set up by your Bang & Olufsen retailer.**

- If you use a Beo6 remote control, it must be reconfigured before you can use the HDMI Matrix.
- You cannot connect more than one HDMI Matrix in a setup.

## Settings in the HDMI MATRIX menu ...

In the HDMI MATRIX menu, you can select settings for your HDMI Matrix.



## Connect an HDMI Matrix...

- > Open the HDMI MATRIX menu.
- > Highlight MATRIX CONNECTED and use the navigation button left to open the selection.
- > Select an HDMI socket and press the **centre** button twice.
- > Download a PUC table for the connected HDMI source. Follow on-screen instructions.
- > Highlight the downloaded PUC table and press the **centre** button.
- > Select a PUC socket and press the **centre** button.
- > Select the control type to be PLUG.
- > Select modulation mode.
- > Press the **centre** button to store the HDMI Matrix settings.
- > Press the **centre** button to continue.

The HDMI Matrix is now configured. Then you have to configure the sources connected to the HDMI Matrix in the SOURCE LIST SETUP menu. This is done the same way as other connected equipment.

*If you at a later time disable a stored HDMI Matrix configuration by setting the HDMI Matrix field to NO, your settings for INPUTS are still saved. This means that if you set the field to YES later, the settings reappear.*

To unconfigure a source [see page 14](#).

# The pin code system

The pin code system is intended to make normal use of your television impossible for someone who does not know the pin code. You choose whether or not to activate the pin code system.

When the pin code system is enabled and the television has been disconnected from the mains for 15–30 minutes, the pin code system is activated.

When reconnected and switched on, the television automatically switches itself off after three minutes if you do not enter the pin code.

**IMPORTANT!** *If you are prompted for a pin code the first time you switch on your television, enter the pin code provided by your Bang & Olufsen retailer.*

## Activate the pin code system

If the pin code system is already activated, you are prompted to enter your pin code when you bring up the PIN CODE menu. You can activate or deactivate your pin code at all times and you can change your pin code.

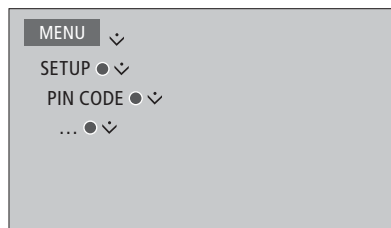

*If you inadvertently press a wrong button while entering a code, press the **yellow** button to delete a digit or press the **red** button to clear an input field.*

*Five incorrect entries will cause the television to shut down for three hours, during which operation is not possible. The standby indicator will flash red quickly.*

*If you change your pin code more than five times within a three-hour period, the PIN CODE menu becomes inaccessible for three hours, provided that the television is not disconnected from the mains. Disconnecting the television resets the three-hour period.*

*Should you lose or forget your code, contact your Bang & Olufsen retailer. Your retailer can provide you with a mastercode, which disables your pin code.*

# Software and service update

We recommend that you enable automatic software update on your television to ensure that your television always has the latest features and functions.

If your television is set up in a system with the BeoLink Converter NL/ML it is essential that you enable the automatic system update to ensure that all products in your system are kept up to date and are able to communicate.

You can always look up software information and update the TV software manually.

## Update software

To download available software updates, your television must be connected to the Internet. It is recommended that you set the television to update software automatically.

You can also download available software updates from [www.bang-olufsen.com](http://www.bang-olufsen.com) onto a USB device. Connect the USB device to the USB port on the connection panel.

On some markets, it is also possible to update the software via the antenna signal (OAD). When you update via the antenna signal, some updates are required and not possible to cancel.

Contact your retailer for more information about software updates.

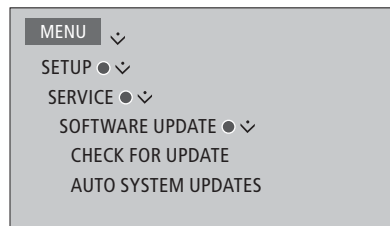

*While the television is updating with new software, the standby indicator flashes red and the television should remain connected to the mains.*

### System update ...

If you have a system setup with a BeoLink Converter NL/ML and several Bang & Olufsen products, the entire system is updated, when you check for updates. You should enable automatic software update of the system in the television menu. Available software updates for all the Bang & Olufsen products in your setup will then be downloaded automatically on a regular basis.\*<sup>1</sup>

*<sup>1</sup>\*You can only enable or disable automatic software updates on the entire system and not on a single product.*

---

## See software information

You can look up information about the current software version, its release date, and any release notes available.



# Peripheral Unit Controller tables

With an Internet connection you can download Peripheral Unit Controller (PUC) tables enabling you to operate connected equipment, such as a set-top box, with the Beo4/Beo6 remote control.

PUC tables are available for many other brand products, such as television screens, projectors, DVD players, set-top boxes, and game consoles. The list of PUC tables on the Internet is updated and expanded on a regular basis.

## Download or remove PUC tables

Normally you configure the source when connected as explained [on page 13](#) but you can also download a PUC table later on.

If the PUC table you are searching for is not in the list, or if you need more information about PUC tables in general, contact your Bang & Olufsen retailer.

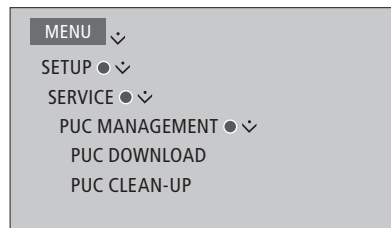

*You can also delete PUC tables, however, you must first unconfigure the connected product belonging to a PUC table. [See page 14.](#)*

*Depending on your IR-controlled PUC equipment, you may have to press **SHIFT + 9** on your Beo4, to switch on the equipment. **SHIFT** can be found in the Beo4 **LIST**.*



# Digital Text

Your television supports Digital Text/MHEG, which is required by some countries and CA modules, among other to activate different MHEG applications when available for a channel. When Digital Text is enabled, operation of the television with a Beo4 will differ in a few aspects from otherwise described in this guide.

## Enable Digital Text/MHEG operation

If your country or CA module requires activation of Digital Text, you may need to enable the Digital Text function yourself.

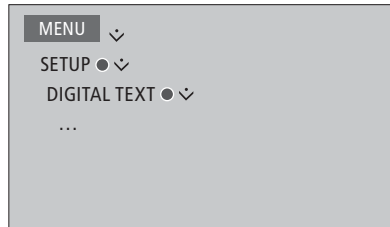

*Digital Text features can vary in appearance and are activated by pressing **Text** or a coloured button.*

*When Digital Text is enabled and no menu is shown on the screen, you must press **MENU** before a coloured button to activate a function.*

# Teletext

You can operate teletext through the menu bar at the top of the teletext page or the arrow buttons on your remote control. You can also store favourite teletext pages for quick reference.

If Digital Text is enabled and an MHEG application is available for the current channel, pressing **TEXT** will activate this application and not the regular teletext function.

When teletext is activated, press **TEXT** to swap between dual screen and full screen mode.

## Daily operation

### To start and exit teletext ...

Press to access the teletext start page

**TEXT**

Press to return to the previous page

**BACK**

Press and hold to exit teletext

**BACK**

### To move to page ...

Access teletext pages you wish to see

**0-9**

Press to step up or down in pages

**▲▼**

Press to move to PAGE and step, or ...

**<◇**

... press to select page

**0-9**

Press to go to index pages

**●**

### To stop subpages from turning ...

Press to stop turning, or ...

**STOP**

... move to HALT and press

**<>**

Press to select subpage

**◇**

or

**0-9**

Restart turning

**●**

### To enlarge teletext page ...

Press to move to LARGE

**<>**

Press to switch between upper and lower half of the page and normal viewing

**●**

To reveal hidden text on a teletext page, move to **REVEAL** and press the **centre** button.

## Store favourite teletext pages

Nine MEMO pages are available for each TV channel's teletext service.

### To create a MEMO page ...

Bring up a page you view often



Press to move the cursor along the menu bar to SETUP and press the **centre** button. The 9 available MEMO slots are shown by number



Press to store the current page. The cursor moves to the next available MEMO slot



Press to select the next teletext page you wish to store



Repeat the procedure for each page you wish to store

Press to leave the MEMO setup, move the cursor to BACK on the teletext menu bar and press the **centre** button



## Daily use of MEMO pages

You may wish to refer to your teletext MEMO pages quickly, for example, if you are leaving for work and wish to check traffic information on a teletext service.

### To view MEMO pages ...

Press to bring up teletext



Press to move between MEMO pages



### To delete a MEMO page ...

Press to move the cursor to SETUP and press the **centre** button



Press to move the cursor to the MEMO page you wish to delete and press the **yellow** button



### To view teletext subtitles for a programme ...

If you want available teletext subtitles to appear automatically for a particular programme, store the teletext subtitles page as MEMO page 9.

# Operate other equipment with Beo4 or Beo6

The built-in Peripheral Unit Controller (PUC) acts as an interpreter between connected video equipment, such as a set-top box, video recorder or DVD player, and your Bang & Olufsen remote control.

Use the Bang & Olufsen remote control to gain access to the functions offered by your non-Bang & Olufsen equipment.

When you switch on the equipment, the functions are available via a menu-overlay on the television screen, or via the Beo6 display.

For instruction in the various functions offered by your equipment, see the product's own guide.

Some features and functions of the television may not be available when non-Bang & Olufsen equipment is connected. Not all connected video equipment is supported by Bang & Olufsen. For more information about supported equipment, contact your Bang & Olufsen retailer.

## Use the Beo4 remote control

With a Beo4 remote control, some functions are available directly via Beo4 when you switch on the equipment. Additional functions are available through a menu overlay that you bring up on the screen. In this menu, you can see which Beo4 buttons activate specific services or functions.

Your Bang & Olufsen retailer can provide you with a 'PUC mapping' overview which explains operation of the connected equipment with Beo4 in more detail.

Press the source button configured for a connected piece of equipment to switch it on, such as DVD

DVD

Press to bring up the main menu including source related functions

MENU

Press to activate the function you want

1 - 9  
or



SOURCE LIST	
RECORDINGS	
SETUP	
RECORD	■
PROGRAMME GUIDE	■
CHANNEL/STATION LIST	■
INFORMATION	■
CHANNEL/STATION GROUPS	1
SUBTITLE LANGUAGE	2
AUDIO LANGUAGE	3
HBTV	4
ACCESS CA-UNITS	5

*Example of a menu overlay. The Beo4 buttons are shown to the right on the menu, and the functions they control are shown to the left. The menu may also list buttons on the remote control included with your connected equipment.*

### Direct Beo4 operation

If you know which coloured Beo4 button activates the function you want, you can activate the function without bringing up the menu overlay first.

*While your equipment is on ...*

Press to activate a function



Press and hold to bring up the Programme Guide or the 'Now/Next' banner on the screen if you are using equipment that supports these functions



Press to activate the function you want

MENU

1 - 9

*Some IR-controlled PUC equipment have to be switched on using SHIFT + 9 on your Beo4 remote control. SHIFT can be found in the Beo4 LIST.*

## Use the Beo6 remote control

The main functions of your equipment can be operated with the Beo6 remote control. Not all functions may be supported by Beo6. The available services and functions are shown in the Beo6 display when you activate the equipment.

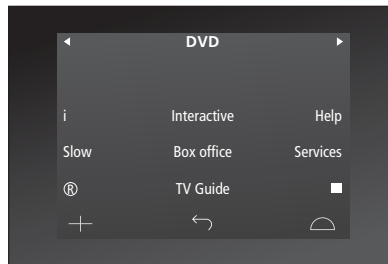

Press a source button to switch on connected equipment, such as DVD

DVD

*Example of a Beo6 display used to operate a set-top box.*

Press the button on the Beo6 display that activates the function you want, or ...

...

... press to bring up the main menu including source related functions

Menu

Press the button that activates the function you want

1 - 9

or



# Network settings

You can set up your television to a network either with a wired or wireless connection. For the most reliable network connection, Bang & Olufsen recommends making a wired connection.

Bang & Olufsen also recommends that you use a separate router and access point – a Network Link router – to ensure the most reliable playback of digital files.

For more information about Bang & Olufsen network setup, contact your Bang & Olufsen retailer.

On some markets, it is not possible to set up a wireless connection, and you must use a wired connection.

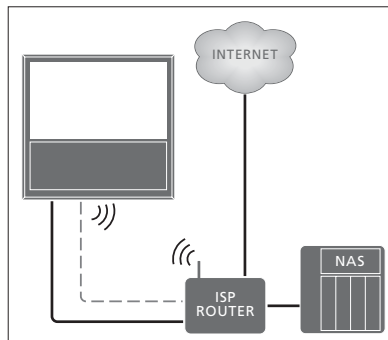

Example of simple setup either wired or wireless.

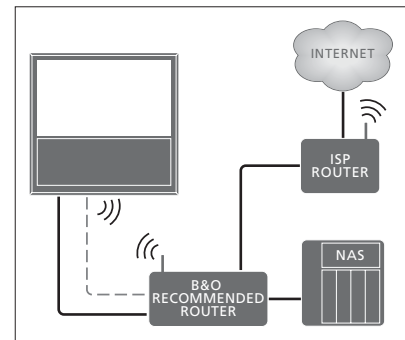

Example of recommended network setup either wired or wireless.

## Make a wired connection

Connect one end of the Ethernet cable to the router and the other end to the Ethernet socket on the television. It is assumed that you have enabled the DHCP service on your network.

If LAN settings are set to configure automatically, IP address, subnet mask, gateway and DNS server are assigned automatically. If the settings are set to configure manually, or if the IP address, subnet mask, gateway and DNS server, for some reason, are not assigned automatically, you must bring up this information manually.

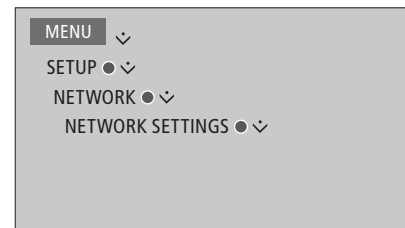

- > Press the **green** button to be able to name the LAN connection.\*<sup>1</sup>
- > Press the **centre** button to store the name and return to the LAN SETTINGS menu.
- > Use the navigation button down to highlight CONFIGURATION.
- > Use the navigation button left or right to select MANUAL or AUTOMATIC configuration.
- > Press the **centre** button to store the setting.

If you have selected MANUAL configuration, you must enter a value for the IP ADDRESS, SUBNET MASK, GATEWAY, and DNS. Press the **centre** button to store the settings.

<sup>1</sup>\*You can only use latin characters for naming the LAN connection.

## Make a wireless connection

If your router has the WPS feature (wireless protected setup), you can make a wireless connection to your network automatically. You can also make the connection manually. It is assumed that you have enabled the DHCP service on your network and that the SSID is not hidden.

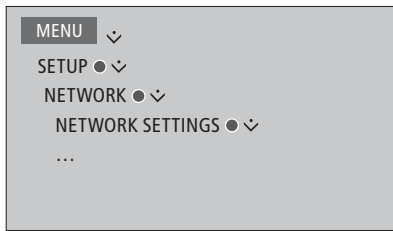

### Connect to a wireless network automatically ...

- > Press the **centre** button to bring up the WLAN SETTINGS menu and highlight WLAN.
- > Press the WPS button on your router to activate the WPS feature.
- > Use the navigation button left or right to enable wireless LAN and store the setting.
- > Use the navigation button down to highlight WLAN PROTECTED SETUP and press the **centre** button to bring up the menu. Here you can see a status of the wireless connection. When CONNECTED is shown on the screen, your television is configured correctly on your network.
- > Press the **centre** button to return to the NETWORK menu.

### Connect to a wireless network manually ...

- > Press the **centre** button to bring up the WLAN SETTINGS menu and highlight NETWORK LIST.
- > Press the **centre** button to bring up the NETWORK LIST menu.
- > Press the **yellow** button if you wish to refresh the list of networks.
- > Use the navigation button up or down to highlight a network router and press the **centre** button to be able to enter the password.
- > Use the navigation button to enter the password to your wireless network and press the **centre** button to establish a connection. When CONNECTED is shown on the screen, your television is configured correctly on your network.
- > Press the **centre** button to return to the NETWORK menu.

### Check your wireless network signal ...

- > Bring up the NETWORK INFO menu and highlight ADVANCED INFO (WLAN).
- > Press the **centre** button to bring up the ADVANCED INFO (WLAN) menu.
- > Check the signal strength in the LEVEL menu:
  - \*\*\*\*\* Excellent connection
  - \*\*\*\* Very good connection
  - \*\*\* Good connection
  - \*\* Stable connection
  - \* Unstable connection

For more information about your router, see the guide enclosed with it.

Your television supports 2.4 GHz and 5 GHz. For more information, contact your Bang & Olufsen retailer.

*Note that your television must be connected wirelessly to access this menu.*

## See network information

You can see information on your network connection in the NETWORK INFO menu.

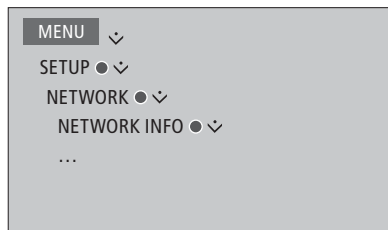

*Note: A previously well-functioning setup may develop problems over time as surroundings change. Check your Ethernet connection or router. If the problem persists, contact your Bang & Olufsen retailer.*



# Distribute sound with Network Link

BeoLink Converter NL/ML makes it possible to distribute sound but not video signals to other rooms throughout the house.

For example, you can connect your television in the living room to an audio or video system in another room, thereby making it possible to 'move' the sound to other rooms.

Access sources from another Bang & Olufsen product and share speakers easily via the television menu.

*Some content providers may have blocked distribution of sound.*

*For information about integrating an audio setup, [see page 59](#).*

## Link connections

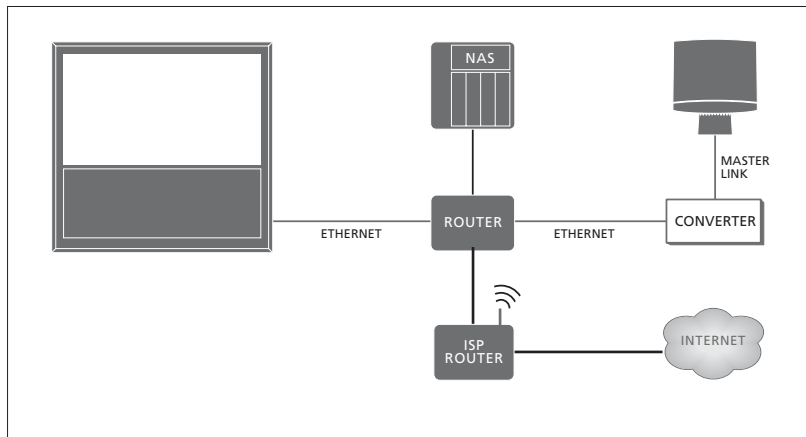

The main room television must be connected to the link room system with BeoLink Converter NL/ML if the link room system is an audio system with Master Link:

- > Connect an Ethernet cable to the socket marked  on the television. Then run the cable to a router, which is connected to the router connected to the Internet.
- > Connect one end of an Ethernet cable to the router and the other end to BeoLink Converter NL/ML.
- > Connect one end of a Master Link cable to BeoLink Converter NL/ML and the other end to the socket marked MASTER LINK on the audio system.

*A Bang & Olufsen product with Network Link is connected directly to the same network (router) as your television.*

*For more information about network settings, [see page 54](#).*

## Integrate external equipment

You can integrate external equipment with your television to listen to music from an audio system or a television.

You can listen to audio and video sources from another Bang & Olufsen product, if the product is connected to the same network (router) as your television. When connecting to an audio system with MasterLink, a BeoLink Converter NL/ML is required to act as a 'bridge' between the network and Master Link, and you can listen to audio sources.

In the PRODUCT INTEGRATION menu, you can select which products to integrate with. A list of products identified on the home network is shown.

To borrow sources from a product, such as radio or CD, you must set it up in the CONNECT TO menu. To select the product, it must be switched on for it to show up as a product found in the list. When you have chosen the product once in the CONNECT TO menu, the sources that can be borrowed are shown in the SOURCE LIST with a 'link' symbol next to them.

A source can play simultaneously on speakers in different rooms and if the connected product does not have local speakers, it is possible to share speakers in television also when a source is activated on the connected product. If you want the television speakers to be activated when you switch on a 'link' source, you must set it up in the SHARE SPEAKERS menu.

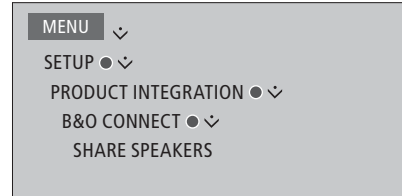
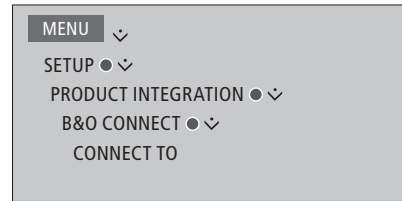

*For information about connecting an audio system or a television for integration with your television, [see pages 59 and 62](#).*

When the television is part of a system setup, it will automatically set WAKE ON LAN/WLAN to ON to be able to switch on connected equipment. Note that this will increase the power consumption slightly.

When a BeoLink Converter NL/ML is a part of your system, six audio sources are listed as sources you can borrow, whether or not equipment is connected to these sources. Sources that do not have connected equipment can be hidden from the SOURCE LIST in the SOURCE LIST menu.

# Connect and operate an audio system

If you connect a compatible Bang & Olufsen audio system to the television, you obtain the benefits of an integrated audio/video system.

Play music on your audio system using speakers connected to the television, or switch on a TV programme and send the sound to your audio system speakers. Also [see page 58](#) about sharing speakers.

Your AV system can be placed together in one room or in two rooms with the television placed in one room and the audio system with a set of speakers placed in another.

**Not all Bang & Olufsen audio systems support integration with the television.**

*If you move your link room products to other rooms, remember to have your Beo6 remote control reconfigured by your Bang & Olufsen retailer.*

*Some content providers may have blocked distribution of sound.*

## Connect your audio system to the television

### Option setting for the television

Option setting of the television is done via the PRODUCT INTEGRATION menu where you also select which product the television is connected to.

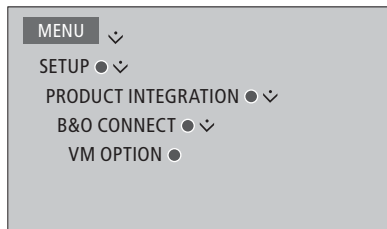

*In the VM OPTION menu highlight the option you want and press the centre button.*

*See the next page for examples of correct Options.*

### Option setting for the audio system

When you have connected your audio and video system, you must set the audio system to the correct Option.

#### Beo4 operation ...

While holding the **•** button on Beo4, press



Let go of both buttons

Press to bring up **OPTION?** in the Beo4 display



Press to bring up **A.OPT** in the Beo4 display and enter the appropriate number (0, 1, 2 or 4)



#### Beo6 operation ...

Place yourself in front of the audio system

While holding the **•** button, press the **centre** button to bring up the **SETUP** menu on Beo6



Let go of both buttons

Press to bring up the Option Programming display on Beo6



Press the button that matches the zone in which the audio system is placed, for example, **Audio Area**



>> Connect and operate an audio system

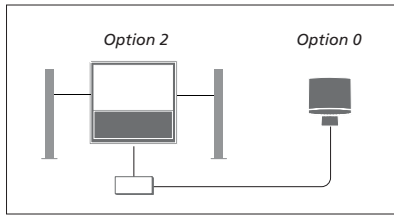

The television and an audio system is set up in one room with all speakers connected to the television:

- Television: VM OPTION 2
- Audio system: Option 0
- SHARE SPEAKERS: YES

Note that the audio system must be selected once in the CONNECT TO menu and you can share speakers in the SHARE SPEAKERS menu, [see page 58](#).

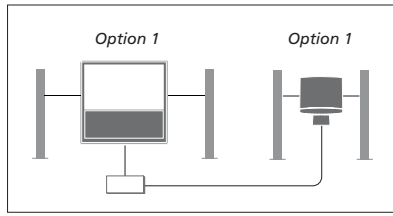

The television (with or without additional speakers) and the audio system (with a connected set of speakers) is set up in the same room:

- Television: VM OPTION 1
- Audio system: Option 1
- SHARE SPEAKERS: NO

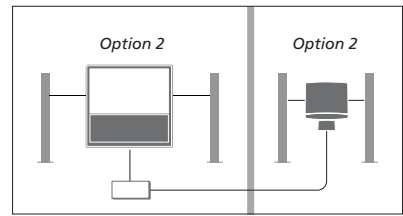

The audio system is set up in one room, and the television (with or without additional speakers) in another:

- Television: VM OPTION 2
- Audio system: Option 2
- SHARE SPEAKERS: NO

For information about Option 4, [see page 61](#). For more information, contact your Bang & Olufsen retailer.

## Use an audio/video system

If you integrate your audio system and your television, you can choose a speaker combination appropriate to the current video or audio programme, and also record video sound on the audio system.

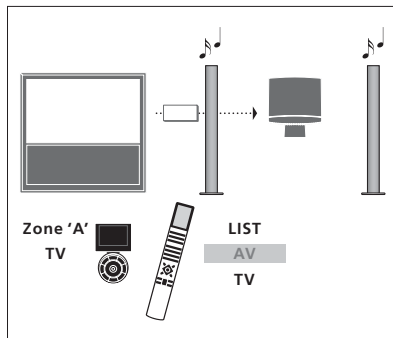

To listen to sound from a television source on your audio system speakers without switching on the screen, press **LIST** and use the navigation button up or down to bring up **AV** in the Beo4 display, then press **TV**. (Beo6: select the zone for your audio system speakers on Beo6, and then press a source button, such as **TV**). Beo6 instruction is shown to the left and Beo4 instruction to the right.

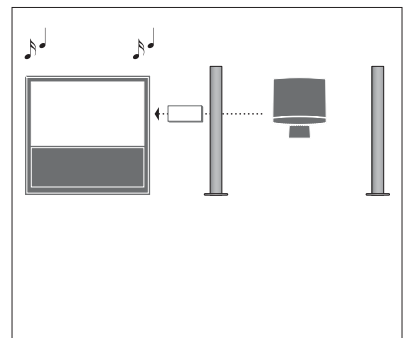

To listen to audio sound on the speakers connected to the television, bring up the **SOURCE LIST** and select the desired source from the audio system listed with a 'link' symbol next to it.

# Operate two televisions in one room

If you have placed your television in a room where you already have a Bang & Olufsen television, and commands from your remote control can be received by both televisions, you must change the Option setting for one of the televisions. This prevents simultaneous activation of both televisions.

One television must be in Option 1 or 2 and the other television must be changed to Option 4. Connection via a BeoLink Converter NL/ML is not required.

Option setting of your television is done via the PRODUCT INTEGRATION menu, [see page 58](#). Note that if the television is set to Option 4 in the television menu and you use a Beo4 remote control, you must press **LINK** and then select a source on Beo4.

## One remote control for both televisions

For your television to function properly, it is essential that the television is set to the correct Option.

### Beo4 – Operate your television in Option 4 ...

Normally, you can activate a source, such as TV, simply by pressing the relevant source button on your remote control. However, when you set your television to Option 4, you must do the following, if you have a Beo4:

Press to bring up **LINK** in the Beo4 display



Press a source button, such as **TV**



*If you have more than one remote control and a specific Beo4 is always used for the television set to Option 4, you can set up the Beo4 to send commands to this television without pressing LINK first. Find ZONE in the Beo4 setup menu and select LINK.*

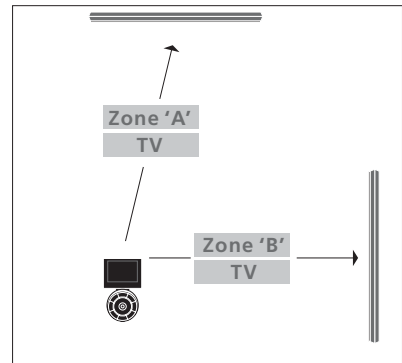
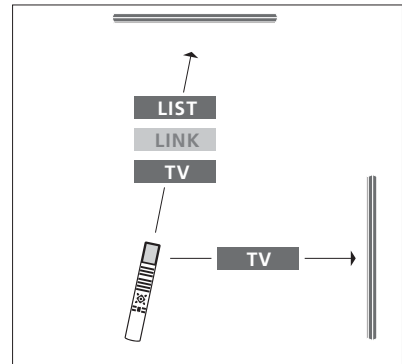

*For information about choice of zone, contact your retailer.*

## Two televisions – with Network Link connection

Products with Network Link can borrow source sound from each other. If you connect a compatible Bang & Olufsen television to your television, you obtain the benefits of an integrated video system that enables you to listen to audio and video sources from the other television.

The two televisions can be placed together in one room or in two different rooms.

Option setting of your television is done via the PRODUCT INTEGRATION menu, [see page 58](#).

Not all Bang & Olufsen televisions support integration with your television.

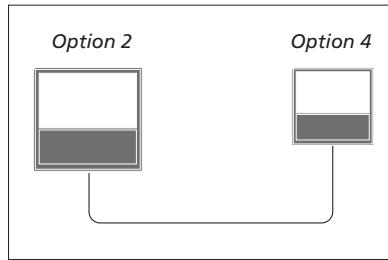

The televisions are set up in the same room:

- The first television: VM OPTION 2
- The second television: VM OPTION 4\*<sup>1</sup>
- SHARE SPEAKERS: NO

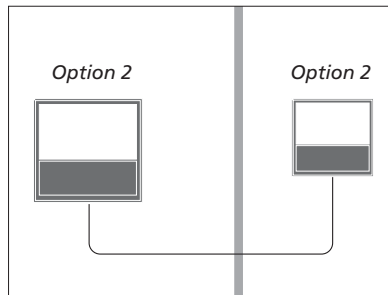

The televisions are set up in two different rooms:

- Both televisions: VM OPTION 2
- SHARE SPEAKERS: NO

<sup>1</sup>\*Note that the television set to Option 4 must be operated with a LINK command, [see page 61](#).

Note that the television must be selected once in the CONNECT TO menu, [see page 58](#).

To listen to audio and video sources on a television, bring up the SOURCE LIST and select the desired source from the other television listed with a 'link' symbol next to it.

If you move your link room products to other rooms, remember to have your Beo6 remote control reconfigured by your Bang & Olufsen retailer.